

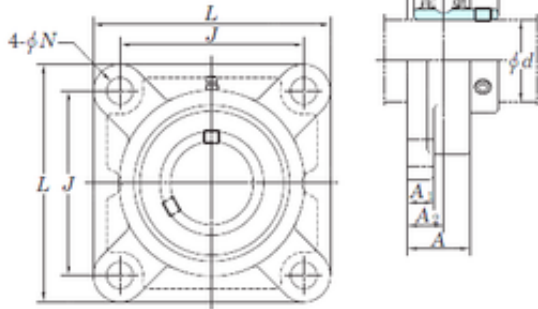

New energy Bearing Manufacturing Co.,...

KOYO UCF210-32 bearing units

Bearing No. UCF210-32



UCF210-32 Bearing 2D drawings and 3D CAD models

Bore Diameter	50,8 mm
d	50,8 mm
A0	54,6 mm
A	40 mm
A1	16 mm
B	51,6 mm
J	111 mm
L	143 mm
N	16 mm
S	19 mm
Bolt (G)	M14
A2	22 mm
Weight	2,5 Kg
Basic dynamic load rating (C)	35,1 kN
Basic static load rating (C0)	23,3 kN